



## Innovating critical metal recovery

MTM Critical Metals (ASX: MTM) is developing potentially disruptive technology for the recovery of metals from ores and waste material sources. It is using a physical phenomenon known as Flash Joule Heating (FJH) that can enhance the process of metal recovery by speeding up the process and lowering the energy inputs involved.

### FJH has substantial potential

FJH could revolutionise the current methods of metal refinery. It has been demonstrated to have an impact on the recovery of lithium, rare earths and gallium. Importantly, the company (through test-work conducted in early 2024) demonstrated that this technology can be scaled and work 50 times greater than the original proof of concept with further scale-up efforts ongoing. It can be used in a chlorinated atmosphere enabling the selective extraction of target metals from feedstock while leaving unwanted elements behind in a very elegant solution. Recent successes include producing lithium chloride directly from spodumene concentrate, a breakthrough that could disrupt the current lithium market.

### An enormous market opportunity

MTM estimates a global market for metal recovery from industrial waste in the order of US\$400bn, while another US\$600bn market exists for improved processing options for refractory minerals. Although the company is realistically a few years away from commercialisation, FJH could make a significant difference by providing a method of recovering metals (particularly lithium and REE) with a substantially lower time and cost than existing methods. Other opportunities include for FJH recovering high valuable metals from e-waste and semiconductor scrap.

### Peers suggest significant upside

We value MTM using a peer-weighted approach at ~\$63.9m or A\$0.16 per share in a base case and ~\$83.0m or A\$0.21 per share in an optimistic (or bull case). We expect MTM to re-rate over the next 12-24 months subject to positive testing results of FJH, as well as optimisation of the technology and potential collaborations with mineral deposit owners and chemical companies. Please see p.21 for more details on our valuation rationale and p.22 for the key risks.

Share Price: A\$0.08

ASX: MTM

Sector: Resources

22 October 2024

Market cap. (A\$ m)	32.3
# shares outstanding (m) <sup>1</sup>	404.2
# shares fully diluted (m)	578.1
Market cap ful. dil. (A\$ m)	44.6
Free float	100%
52-week high/low (A\$)	0.12 / 0.021
Avg. 12M daily volume ('1000)	2,441.2
Website	mtmcriticalmetals.com.au

Source: Company, Pitt Street Research

<sup>1</sup> Including shares in Tranche 2 of the placement

### Share price (A\$) and avg. daily volume (k, r.h.s.)



Source: Refinitiv Eikon, Pitt Street Research

Analysts: Stuart Roberts, Nick Sundich

Tel: +61 (0)4 3483 8134

Stuart.Roberts@pittstreetresearch.com

Nick.Sundich@pittstreetresearch.com

Disclosure: Pitt Street Research directors own shares in MTM.



## Table of Contents

<b>Introducing MTM Critical Metals (ASX: MTM)</b>	<b>3</b>
<b>Introduction to Flash Joule Heating Technology and MTM's Approach</b>	<b>5</b>
<b>MTM's impacts on metals recycling</b>	<b>8</b>
<b>The market for FJH</b>	<b>13</b>
<i>E-Waste</i> .....	<i>14</i>
<i>Bauxite residue (red mud)</i> .....	<i>15</i>
<i>Coal fly ash</i> .....	<i>15</i>
<b>MTM's commercial plan</b>	<b>16</b>
<b>MTM's leadership team</b>	<b>17</b>
<b>Comparable companies</b>	<b>19</b>
<b>Our valuation of MTM</b>	<b>21</b>
<b>Risks</b>	<b>22</b>
<b>Appendix I – Glossary</b>	<b>23</b>
<b>Appendix II – MTM's exploration Assets</b>	<b>24</b>
<i>West Arunta</i> .....	<i>24</i>
<i>Pomme</i> .....	<i>24</i>
<i>East Laverton</i> .....	<i>25</i>
<b>Appendix III – MJM's Capital Structure</b>	<b>27</b>
<b>Appendix IV – Analysts' Qualifications</b>	<b>27</b>
<b>General advice warning, Disclaimer &amp; Disclosures</b>	<b>28</b>



*MTM's FJH Technology allows for the recovery of critical metals from ores and waste.*

## Introducing MTM Critical Metals (ASX: MTM)

MTM Critical Metals is a company whose FJH Technology allows for the recovery of critical metals from ores and waste. The technology, based on an approach called 'Flash Joule Heating' (FJH), originated in the laboratory of Professor James Tour of Rice University in Houston<sup>1</sup>.

The technology which MTM has licensed from Rice can rapidly create very high temperatures inside waste feedstocks such as fly ash, bauxite residue, electronic waste, or mineral ores such as spodumene (a lithium mineral), or monazite (a source of rare earths), facilitating targeted metal recovery in a controlled reactor environment. MTM acquired an option to the FJH Technology in December 2023, and this was exercised in March 2024.

MTM first listed on the ASX as Mt Monger Resources in 2021, and focused on gold exploration. The company pivoted to critical minerals, picking up its Pomme and East Laverton projects and adopted its current name in May 2023. In December 2023, MTM acquired Flash Metals which had REE-prospective territory adjacent to WA1 Resources (ASX: WA1) along an option to license the FJH technology. This option was formally exercised in March 2024 with the license including:

- The recovery of rare earth elements (REEs), metals and metallic compounds from Coal Fly Ash, Bauxite Residue, Ores, Bitumen and Coal,
- The use of processed coal fly ash waste for the lower carbon building materials including cement and concrete,
- The recovery of REE, metals (including gold, silver, platinum and palladium) and metallic compounds from E-Waste (electronic equipment, consumer electronics, power tools, print circuit board, CPUs and smartphones), and
- The recycling of degraded or end of life Lithium-Ion Batteries to recover metals including lithium, manganese, copper, cobalt and nickel.

Over 2024, the FJH technology has become the company's focus as testing has continually shown potential in testing undertaken by the company and given rise to expectation that it could generate shareholder value sooner than any of the company's exploration assets. FJH will accordingly be the main focus of this report, although we will recap MTM's exploration assets in the Appendix section of this report.

## Nine Key Reasons to look at MTM Critical Metals

- 1) **FJH represents a new and improved way to recycle metals.** Traditionally pyrometallurgical and hydrometallurgical metal recovery methods are expensive, energy-intensive, reagent-intensive and non-selective. FJH overcomes these limitations, facilitating metals recovery quicker, using less energy and achieving higher yields in the process.
- 2) **FJH has undergone extensive testing.** Amongst the results depicted to date, FJH has been shown to generate over 70% yields of gold from e-waste, to reduce the necessary 15-molar concentration of nitric acid used in REE extraction to a mere 0.1-molar concentration of hydrochloric acid. Moreover, the company has continued to improve the technology – recent testing (i.e. mid-2024) has shown that FJH's recovery of REE and critical metals was 50% higher than just two years prior.
- 3) **FJH offers investors exposure to critical minerals, without the vulnerability to fluctuating commodity prices.** The fluctuation in commodity prices (particularly for lithium and REEs) have led many



investors to overlook the need for these metals. FJH would make projects feasible that otherwise could not be, because it would lower costs of processing by eliminating steps altogether. Most notably, FJH allows refractory alpha-lithium spodumene to be converted to leachable beta-spodumene without having to be through the usual calcining process

- 4) **FJH has a substantial market opportunity that is expected to continue to grow in the years ahead.** This is not just because of the rise of technologies requiring these metals, but the necessity of using recycling as part of the critical metals supply chain. It goes without saying that it is time-consuming and expensive to bring new mines into production. But in some jurisdictions, such as the EU, there will be requirements for a minimum proportion of metals utilised in technologies to have been recycled. FJH would ensure the process of recycling could be not just sped up, but more effective (in producing higher yields of metals) and less costly.
- 5) **FJH come out of Rice University, which has been home to the founding of several other commercialised technologies.** One such example is Weebit Nano's (ASX: WBT) ReRAM technology. Rice has committed to continue to support MTM as it develops and expands on FJH. We expect this support to be pivotal in facilitating FJH's development in the months and years ahead. After all, MTM has an exclusive worldwide license over this technology.
- 6) **MTM's exploration assets represent further upside.** Although in the short-term, the company's focus is on the FJH technology, it still owns multiple exploration assets with significant potential – particularly its West Arunta projects are immediately adjacent to tenements held by WA1 Resources (ASX: WA1) and Encounter Resources (ASX: ENR). MTM may opt
- 7) **Keys catalysts are coming up that could create shareholder value.** These include, but are not limited to, the Completion of a 1 tonne per day pilot/demonstration plant, establishment of a gallium recovery commercial-scale plant, results related to the testing of bauxite residue and recovery of precious metals (gold, platinum etc) from electronic waste and Partnerships or collaborations with potential strategic customers and joint-venture partners.
- 8) **FJH has a quality leadership team with extensive experience in commercialising early-stage technologies and creating shareholder value in doing so.** Consider that when Rice first licensed the technology, one of the things MTM had to provide was evidence that it had high quality candidates with extensive engineering and scientific experience to develop and commercialise the technology.
- 9) **We believe FJH is undervalued** at its current market value. We think, based on a peer-weighted analysis, the company should be trading at a market cap of A\$63m, which would equate to A\$0.16 per share. As it advances, we see a further upside if the market capitalisations of its peers at a later stage of development are any guide.



## Introduction to Flash Joule Heating Technology and MTM's Approach

MTM is commercialising a form of Flash Joule Heating (FJH) that it has licensed from Rice University. It applies the general principals of FJH to metal recovery from ores and wastes – particularly lithium and Rare Earth Elements (REEs)

**What is Flash Joule Heating?** To put it simply Flash Joule Heating (FJH) is a process that the creation of thermal energy because of the collision of electrons in a conductor...done at a 'flash pace'.

In physics, 'Joule heating' is the phenomenon where the passing of current through an electrical conductor produces thermal energy because of the collision of electrons in the conductor. Joule's law, first described in the early 1840s<sup>1</sup>, holds that the heat generated by such a conductor equals the product of its resistance and the square of the current. Flash Joule Heating is simply this phenomenon but done in a way as to generate heat very quickly. With MTM's FJH Technology, the heat is generated almost instantaneously (the 'flash' part), reaching temperatures as high as 3,000 degrees Celsius in less than a second.

This rapid and intense heating can break down complex materials, making it particularly useful for extracting metals from waste streams or refractory ores. The term 'Flash Joule Heating' is not unique to the Rice laboratory, but what that laboratory has achieved, and what MTM has licensed, is a method to achieve favourable Flash Joule Heating conditions in a controlled atmosphere to economically recover metals from feedstock. This process may utilise chlorine gas or other reactants to selectively recover metals by forming metal chlorides or similar compounds, providing an elegant and efficient solution.

### MTM's FJH

The Flash Joule Heating which MTM is commercialising originated from work at the Rice University to make 'flash graphene', graphene being a valuable and highly versatile carbon derivative<sup>2</sup>. Realising that carbon's high conductivity enabled ultrafast heating, the Rice lab then started using carbon black<sup>3</sup> as a conductive additive to non-conductive feedstocks.

This process was undertaken in reactor vessels made of quartz with graphite electrodes at each end, through which electrical pulses were applied. As we noted above, the result was a massive 3,000 degrees Celsius of heat in just a fraction of a second, which is high enough and fast enough to allow metal recovery much easier than conventional approaches.

This extreme heat generated in the process allows for either the direct volatilisation of metals or makes them more easily extractable using conventional acid leaching techniques (Figure 1). The thermal shock renders refractory minerals 'unrefractory', and using controlled reagents like chlorine, metals can be selectively recovered from a bulk mass. Rice University has filed for patent protection over this approach, and the patent application was published in March 2022<sup>4</sup>.

*Flash Joule Heating involves the creation of thermal energy because of the collision of electrons in a conductor...done at a 'flash pace'.*

*This rapid and intense heating can break down complex materials, making it particularly useful for extracting metals from waste streams or refractory ores.*

*The extreme heat generated in the process allows for either the direct volatilisation of metals or makes them more easily extractable using conventional acid leaching techniques.*

<sup>1</sup> The renowned English physicist James Prescott Joule (1818-1889) submitted his work on Joule heating to the Royal Society in 1840, which published an abstract in its *Proceedings* that year. A full paper was published in *Philosophical Magazine* in October 1841 entitled *On the Heat Evolved by Metallic Conductors of Electricity*.

<sup>2</sup> See WO/2020/051000, priority date 19 August 2019. A company called Universal Matter is producing graphene using the Flash Joule Heating technology and has already scaled to more than 1 tonne per day and is moving towards 3 tonnes per day. See [universalmatter.com](http://universalmatter.com).

<sup>3</sup> A material commonly used as a pigment and reinforcing phase in car tyres.

<sup>4</sup> See *Ultrafast flash joule heating synthesis methods and systems for performing same*, WO/2022/067093, priority date 24 September 2020. Invented by James Tour and Bing Deng.



***Rice's FJH approach reduces the concentration of nitric acid required from a level of 15-molar to 0.1-molar, with higher yields of end-product. This will dramatically reduce the energy consumption, capex and opex for certain metal applications.***

***Recovery of REE and critical metals was 50% higher than that published in 2022, and the testing was successfully conducted at 50 times the scale of Rice University's original proof of concept.***

## How efficient is it?

A key paper in the journal *Science Advances* in early 2022<sup>5</sup> described the use of FJH in the case of rare earth elements (REEs) from coal fly ash. In this study the technology's aim was to create soluble 'activated REE species', that is, metal oxides rather than phosphates that required very small amounts of acid to leach. Ordinarily a 15-molar concentration of nitric acid is used in REE extraction. The Rice Laboratory's carbon-based Flash Joule Heating approach reduced this to a mere 0.1-molar concentration of hydrochloric acid, with higher yields of end-product. Why is this important? Because this (the lower concentration of hydrochloric acid) will dramatically reduce the energy consumption, capital expenditure and operating expenditure for certain metal applications such as lithium. In the case of energy, Rice believes it can come down by more than 50%. This would be 'game changing' for lithium and the mineral extraction and processing industry generally.

The Rice lab has used the FJH Technology to extract critical metals like REEs, nickel, cobalt and lithium from natural ore mineralisation and from waste material including lithium-ion batteries, electronic waste, coal fly ash produced by coal-fired power stations, and 'red mud' derived from bauxite processing in the aluminium industry. We will delve into the specific impacts FJH can have on some of these individual applications shortly. MTM's worldwide exclusive license to the FJH Technology, which was granted in May 2024, covers all these areas.

The technology was initially proven at a laboratory-scale in the Rice lab, and a Houston-based firm called KnightHawk Engineering<sup>6</sup> has independently verified the Rice work. Of course, any impact on a laboratory scale would be immaterial if it could not be replicated on a larger scale. But recent test work has demonstrated that the FJH Technology can scale.

## MTM's recent work

In April 2024 MTM announced that a prototype version of the company had completed development, while in May 2024 MTM announced testing of this prototype had markedly improved the acid leachability of REEs and target critical metals from coal fly ash (Figure 1). Recovery of REE and critical metals was 50% higher than that published in 2022, and the testing was successfully conducted at 50 times the scale of Rice University's original proof of concept. We will delve into the specific impacts MTM has on individual commodities in the next section of the report.

<sup>5</sup> Deng et. al., *Rare earth elements from waste*, Science Advances, 9 February 2022.

<sup>6</sup> See [knighthawk.com](http://knighthawk.com).



Figure 1: The effect of FJH

Element		Head Grade (SGS - ppm)	Leach Recovery Results (Pre FJH) (µg/L)	Leach Recovery Results (Post FJH) (µg/L)	% Change in Recovery
Rare Earth Elements (REE)	Nd - Neodymium	72	637	1,095	72
	Pr - Praseodymium	18	188	285	52
	Dy - Dysprosium	14	367	444	21
	Tb - Terbium	2	41	62	50
	<b>TOTAL MREE</b>	<b>106</b>	<b>1,233</b>	<b>1,886</b>	<b>53</b>
	Ce - Cerium	153	1,482	2,377	60
	Er - Erbium	8	277	350	26
	Eu - Europium	3	37	56	50
	Gd - Gadolinium	16	256	367	44
	Ho - Holmium	3	86	121	40
	La - Lanthanum	74	752	1,197	59
	Lu - Lutetium	1	65	79	22
	Sm - Samarium	15	149	232	55
	Tm - Thulium	1	44	58	31
	Y - Yttrium	81	1,346	1,961	46
Yb - Ytterbium	7	319	381	20	
<b>TOTAL REE</b>	<b>468</b>	<b>6,046</b>	<b>9,065</b>	<b>50</b>	
Other Elements of Interest	Al - Aluminium (%)*	*10	5,814,146	9,497,618	63
	Ba - Barium	978	4,777	3,499	-27
	Co - Cobalt	45	558	964	73
	Cs - Cesium	7	120	333	176
	Li - Lithium	125	3,248	4,857	50
	Ni - Nickel	102	1,214	2,412	99
	Rb - Rubidium	93	1,141	2,427	113
	Sc - Scandium	27	694	1,409	103
	Ti - Titanium	5,900	1,626	9,990	514
	V - Vanadium	205	6,052	1,320	-78

Source: Company

Another important step MTM has recently made was securing an addition to its license with Rice, which would allow MTM to use FJH in a chlorinated atmosphere. Chlorination is important process step in the extraction of many metals from their ores and concentrates, because once the metal of interest combines with the chlorine it is easy to fish out. This agreement was an important step for MTM because it can further reduce water and reagent consumption.



*FJH would make metals recycling faster and more efficient.*

## MTM's impacts on metals recycling

To make a long story short, FJH would make metals recycling faster and more efficient. The advantage of MTM's FJH Technology lies in its ability to enhance existing processes, particularly in lithium recovery.' MTM's key verticals are Industrial Waste Streams and Refractory Mineral Processing Operations.

## Conventional metals recycling and the problems with it

Traditional metal recycling (Figure 2) falls into one of two categories. First, pyrometallurgical metal recovery methods such as smelting, incineration, combustion and pyrolysis. Secondly, hydrometallurgical metal recovery methods - using varying types of industrial sludges.

Figure 2: The typical recycling process

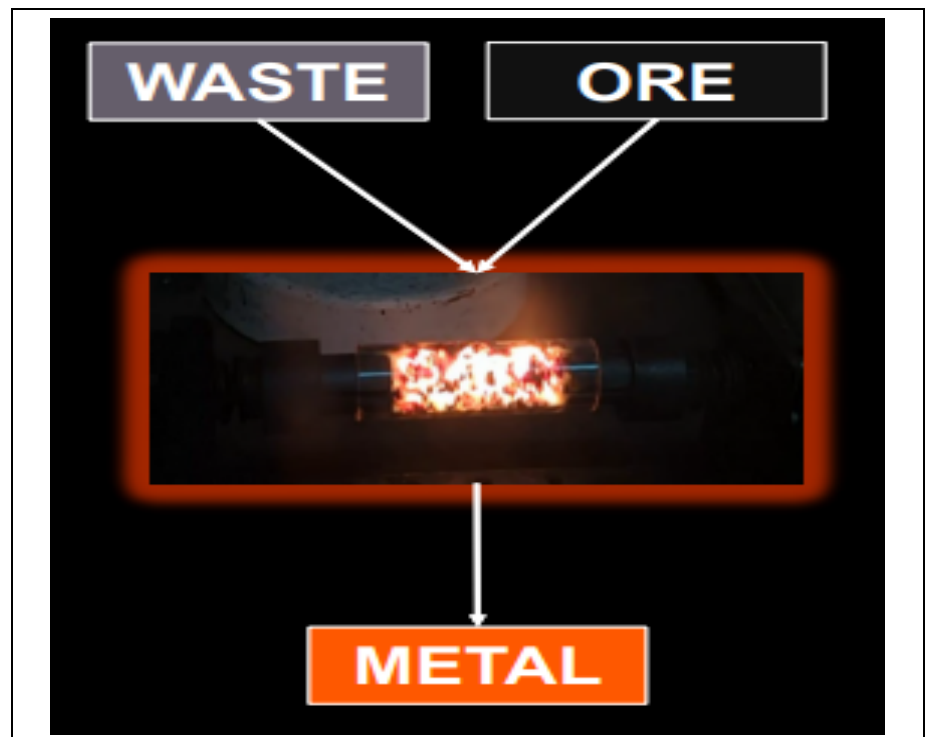

Source: Company

These methods are:

- **Expensive** for the reasons immediately below (among others),
- **Time-consuming** - it can take multiple hours to achieve the temperature required for metals to melt so they can be recycled),
- **Energy-intensive** meaning the processes use a substantial amount of energy,
- **Reagent-intensive** which is to say a significant proportion of reagents (compounds added to cause the necessary chemical reactions) are required; and are,
- **Non-selective**. In other words, metal recovery methods don't just remove the metal of interest but take out all the metals as well.





MTM's FJH Technology overcomes these problems, general to all metal recovery methods, as well as some specific problems to individual commodities. MTM has three target commodities: Lithium, REEs and Gallium. In respect of each of these, FJH could help shorten the process and bring down the time and cost of them.

## 1) Lithium and Lithium Battery Waste

*Demand for lithium will increase 475% from 2023 levels by 2035. Metals recycling will play a key role in ensuring demand can be met.*

Lithium is the most important of battery metals. Demand for lithium has skyrocketed over the last three decades in conjunction with the rise of technologies that need lithium-ion batteries. In 1995, 9.5kt was mined worldwide, a figure that had reached 106kt by 2021<sup>7</sup>. Moreover, the end markets for lithium shifted from ceramics and glasses over to technologies that use batteries with lithium such as electric vehicles. This demand is expected to accelerate in the years ahead. A study by Mckinsley in September 2024 estimated that demand for lithium will increase 475% between 2023 and 2035<sup>8</sup>. A conventional EV needs around 8kg of lithium<sup>9</sup> and lithium is just one of several inputs into a battery (Figure 3). Metals recycling will play a key role in ensuring demand can be met.

Lithium-ion batteries (LiBs) are a commodity in themselves, particularly once retired. They do not just contain lithium, but other metals too. For example, a NMC 111 battery contains 11% lithium, 30% nickel, 31% cobalt and 28% manganese. Furthermore, battery metals account for up to 30% of the battery by weight which is far greater than other resources. Upon retirement, the batteries can be collected, fully discharged, then shredded and base metals separated to prepare them for recycling.

Figure 3: A typical lithium-ion battery

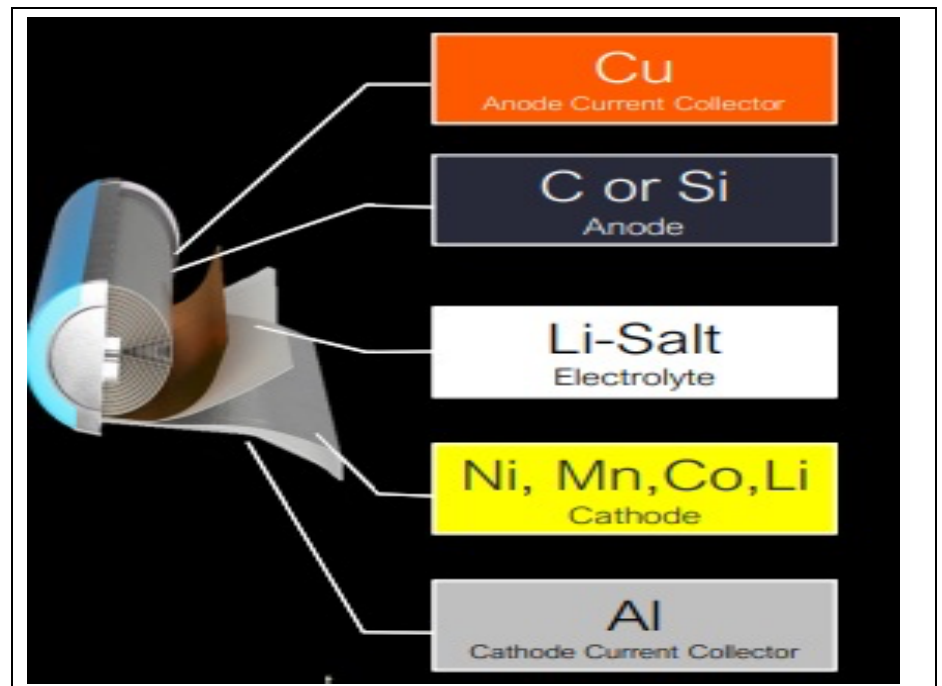

Source: Company

<sup>7</sup> World Economic Forum Data.

<sup>8</sup> <https://www.mckinsley.com/industries/energy-and-materials/our-insights/global-materials-perspective>

<sup>9</sup> Sustainability by Numbers data



*FJH can improve the energy-intensive 'calcination' step in lithium extraction.*

While the demand for lithium has changed – not just numerically but by composition – the methods of lithium production have not. Traditional lithium flowsheets, developed over 70 years, involve the use of calcination and roasting which consume a high amount of energy and have a high degree of carbon emissions. They also require significant acid and other reagent consumption due to several impurity removal steps (Figure 4). There is a substantial capex and operating cost.

For lithium, MTM has recently demonstrated that FJH can improve the energy-intensive 'calcination' step in lithium extraction<sup>10</sup> - termed Acid Roasting in Figure 4. Even more impressively, the technology has shown potential to dramatically streamline the extraction process by reducing the number of steps required to recover lithium from spodumene concentrate. Earlier in 2024, FJH was shown to produce a saleable product—lithium chloride—directly from raw concentrate in a single step<sup>11</sup>. This breakthrough holds significant commercial promise. If scalable, it could revolutionise the current methods of lithium refining and disrupt the industry.

Figure 4: Lithium flowsheet

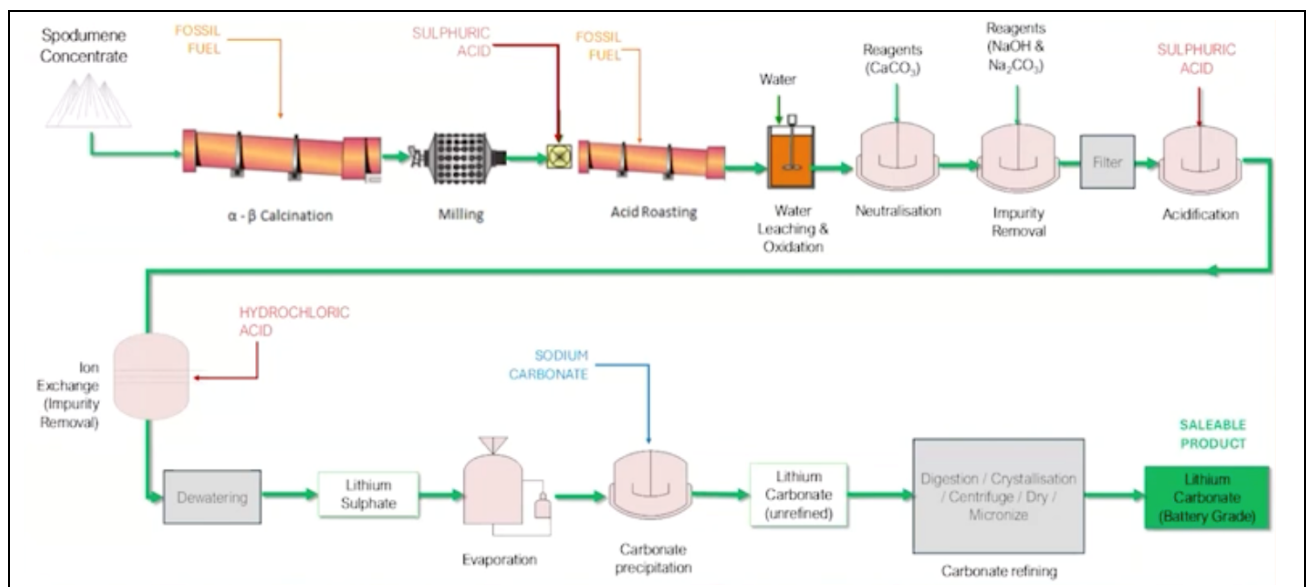

Source: Company

## How FJH could help lithium processing

- **FJH could potentially improve the processing of spodumene from hard rock lithium mines**, by allowing refractory alpha-spodumene to be converted to leachable beta-spodumene without having to be through the usual calcining process. This could potentially lower the energy inputs involved. The conversion has already been successfully applied in the laboratory, with MTM reporting in July 2024 a 92% reduction in calcination time of spodumene concentrate over conventional processes.
- **FJH could be useful in the recovery of lithium from spodumene fines**, a potentially significant commercial opportunity. Currently, spodumene

<sup>10</sup> See the MTM announcement dated 9 July 2024 headlined 'Positive lithium extraction results from Flash Joule Heating'

<sup>11</sup> See the MTM announcement dated 21 August 2024 and headlined 'Flash Joule Heating converts spodumene to lithium chloride'



finer, which can contain up to 20% of the lithium by mass in the ore, are typically discarded as waste in concentrators worldwide due to being unrecoverable by conventional methods. This represents a vast untapped resource, and recovering lithium from this stream could unlock considerable value for both MTM and lithium miners. Discussions are ongoing between MTM and multinational lithium companies to explore potential collaborations.

- **FJH can potentially allow lithium chloride to be produced from spodumene.** In August 2024 the company announced that it had extracted lithium chloride directly from spodumene using the FJH Technology in a chlorinated atmosphere. Lithium chloride is a feedstock in operations to produce lithium carbonate and this approach potentially cuts out the earlier calcining and roasting steps that would precede this, including the alpha-to-beta conversion we discussed above.

## 2) Rare Earth Elements (REEs)

REEs are also commodities that will be in hot demand in the years to come, and where MTM's FJH technology could make a difference. Demand for REEs has been forecast to grow 125% between 2023 and 2035<sup>12</sup>. Historically, the supply chain has been heavily weighted to China as it produces more than 90% of the world's rare earth oxides and it processes nearly 90%<sup>13</sup>. Western nations are keen to secure their own supply chains by discovering new deposits and bringing them into production, but recycling technology could play a part too.

For rare earths, MTM's technology potentially cuts out a lot of the issues in trying to identify, mine and process rare earth deposits. Feedstock necessary for processing can be sourced locally from abundant waste sources, and often utilities and governments will pay to clean up toxic waste. MTM's plants are likely to have low capex given the simplicity of the design. And, importantly, there are no wastewater issues. The use of the technology to obtain rare earths is particularly timely given the geopolitical issues involved.

So far as processing mined rare earths ores is concerned, FJH could potentially improve the processing by removing the need for the 'acid bake/roasting' step where rare earth phosphates are converted to rare earth sulphates. It is necessary in this process to have a high temperature, for higher temperatures improve recovery values compared to leaching. It dehydroxylates the clays and liberates the REE minerals, allowing access for the acid to solubilise the REEs<sup>14</sup>. But FJH technology has the potential to achieve even better results, but faster. As demonstrated in Figure 2 back on page 7, FJH improves the acid leachability of REEs by over 50% and other critical metals by 50-514% when compared to conventional acid leach methods.

Discussions are ongoing between MTM and multinational rare earths companies to explore potential collaborations.

*Demand for REEs has been forecast to grow 125% between 2023 and 2035.*

<sup>12</sup> McKinsley's Global Materials Perspective 2024

<sup>13</sup> Center for Strategic and International Studies

<sup>14</sup> <https://www.tandfonline.com/doi/full/10.1080/19392699.2023.2269094>



### 3) Gallium

Gallium, Atomic No. 31, is a highly valuable metal with a supply chain currently dominated by China. This presents a significant commercial opportunity. The ability for Western countries to 'onshore' high-value gallium production from waste streams offers a commercially compelling advantage for MTM.

For gallium, MTM recently announced a breakthrough in gallium recovery from semiconductor scrap using its FJH Technology<sup>15</sup>. The company is actively engaging with US Federal agencies to explore the development of a commercial-scale plant in America. Recovering high-value gallium from semiconductor scrap presents a compelling near-term commercial opportunity for MTM. Gallium's ultra-high price, strategic importance, and the relatively small volumes needed for viable operations make it an attractive prospect for establishing a dedicated recovery plant quickly

### 4) Gold

*Gold is another commodity where FJH could make a difference, given gold is commonly used in E-Waste.*

Gold is another commodity where FJH could make a difference, given gold is commonly used in E-Waste. For instance, printed circuit boards can contain up to 400g/t gold and 6 kg/t of silver, a concentration even higher than in natural ores. Gold processing is typically done in smelters and incinerators using methods that are expensive, time-consuming, crude to the environment through direct emissions and toxic by-products, and often unregulated. FJH's technology applies direct electrical energy under a chlorine gas atmosphere, thus vaporising metals from e-waste and recovering them in a single step without using toxic acids or non-selective incineration (Figure 5).

Figure 5: E-waste flowsheet

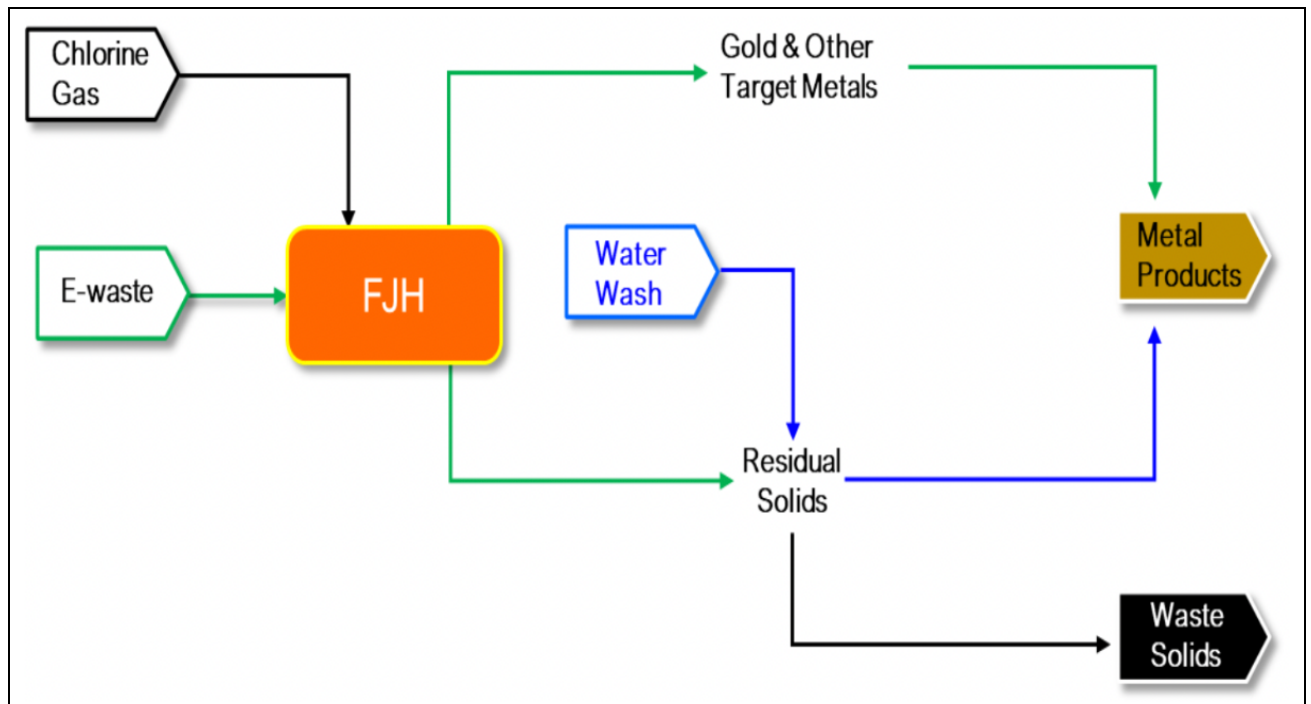

Source: Company

<sup>15</sup> See the MTM announcement dated 27 August 2024 'Gallium recovered from semiconductor waste using FJH tech'



In September 2024, MTM announced that it had successfully used FJH to recover gold from e-waste and achieved yields of up to 70%. The company undertook an initial, unoptimised flash test using samples of shredded 'low grade gold'<sup>16</sup> e-waste. The metals were flashed in a chlorinated atmosphere to facilitate the formation of metal chlorides. After this flashing process, water washes were conducted to remove metal chlorides from the residual solids. Inductively Coupled Plasma Mass Spectrometry (ICP-MS) was used to quantify the metals in both the solid residues and the water wash solutions.

Although this is an unoptimised, proof-of-concept stage, the company has plans to enhance the recovery efficiency for a range of additional valuable metals commonly found in e-waste including copper, silver and palladium in subsequent tests. In this stage, recovery rates were lower because of the sole focus on gold, but the company is developing a dual-stage flash process which will ensure all metals can be efficiently recovered with strong recovery rates not sacrificed for any individual metals.

## The market for FJH

*Metal recycling will become an increasingly important way to fulfil the world's needs for critical minerals.*

Metal recycling will become an increasingly important way to fulfil the world's needs for critical minerals. The world cannot rely on simply finding and developing new products. Recycling will need to be a part of the critical metals supply chain, given the time and cost to bring new deposits into production, not to mention regulations that mandate the use of recycling. In the EU there have long been such regulations, and the most recent legislation (the EU Sustainable Batteries Regulation) which was enacted in August 2023 provides for recovery targets as stipulated in Figure 6.

Figure 6: EU targets for recycling/recovery of metals

Commodity	Targets
Lithium	50% recovery from waste batteries by the end of 2027 and 80% by the end of 2031. Minimum 6% level of recycled content by August 2031 and 12% by 2036. 65% recycling efficiency target for batteries by the end of 2025.
Cobalt	90% recovery target by the end of 2027 and 95% by the end of 2031. 16% minimum level of recycled content by 2031 and 26% by 2036. 50% recycling efficiency target for batteries by the end of 2025.
Copper	90% recovery target by the end of 2027 and 95% by the end of 2031.
Nickel	90% recovery target by the end of 2027 and 95% by the end of 2031. 6% minimum level of recycled content by 2031 and 15% by 2036. 80% recycling efficiency target for batteries (Nickel-Cadmium batteries).
Lead	90% recovery target by the end of 2027 and 95% by the end of 2031. 85% minimum level of recycled content by 2031. 75% recycling efficiency target by the end of 2025 and 80% by 2030.

Source: International Energy Agency<sup>17</sup>

The IEA has projected that by 2040, recycling will provide up to 12% of global cobalt demand, 7% of nickel and 5% of lithium and copper demand. As goes without saying, recycling can't be too expensive and it cannot have too high

<sup>16</sup> Sub 100ppm

<sup>17</sup> <https://www.iea.org/policies/16763-eu-sustainable-batteries-regulation>



a carbon footprint. As we have outlined in this report, FJH offers a viable alternative to conventional critical mineral recycling.

MTM has estimated a global market for metal recovery from industrial waste in the order of US\$400bn, while another US\$600bn market exists for improved processing options for refractory minerals. It has identified 4 specific verticals: Lithium battery waste, E-waste, Bauxite residue and Coal fly Ash.

### E-Waste

In 2022, 62Mt of e-waste was generated globally and only 20% of this was formally recycled. With the proliferation of computer servers, electronic devices, including smartphones, laptops, tablets, and other electronic gadgets, the volume of electronic waste is expected to continue to rise in the coming years - to over 75Mt by 2030<sup>18</sup>. The economic value of the metals in this waste is estimated to be over US\$70bn, including US\$15bn from gold and US\$19bn copper (Figure 7), but much of this is lost because of incineration, landfilling or substandard treatment.

*Only 20% of the world's e-waste was recycled in 2022.*

Figure 7: Breakdown by weight and value of some of the metals contained in global e-waste generate in 2022



Source: Company

As we have noted above, individual technologies can be abundant with particular metals as well as metals generally. Printed circuit boards (PCB's) can contain up to 30% by weight of metals such as copper, zinc, tin, lead, iron, nickel and precious metals such as gold, silver, platinum and palladium. TV

<sup>18</sup> Global E-waste Monitor 2024



boards have 280g of silver, 20g of gold and 10g of palladium *in every tonne*. For computers, they can contain up to 600g/t of gold and 2000g/t of silver.

## **Bauxite residue (red mud)**

“Red mud” is an industrial waste generated during the processing of bauxite into alumina using the Bayer process. Testing of red mud using FJH has been carried out to assess the viability of recovering residual aluminium and other critical metals such as titanium, REE, scandium and gallium. Large resources of bauxite residue already exist globally. Annually about 140 Mt of bauxite residue is produced and the global inventory is expected to reach 10Bt by 2050. Residue storage ponds present a similar environmental challenge to CFA and significant research is underway to both recover critical metals and reduce the amount of material in long-term storage.

## **Coal fly ash**

Recent testing has shown that the FJH technology can increase the recovery of rare earth elements (REE) and other critical metals from coal fly ash (CFA) by improving the susceptibility of the CFA to acid leaching. It is estimated that coal fired power generation produces approximately 900 Mt per annum of CFA. The average REE global grade of CFA is about 445 ppm total rare earth element oxide (TREO), representing approximately 0.5Bt of TREO. The amount of rare earth oxides produced globally in 2023 was 350,000 t of TREO (reference) and global demand is expected to grow to 466,000t TREO by 2035 driven by the demand for electric vehicles, wind turbines etc. Existing CFA deposits in landfill are therefore a very strategic source of REE and other metals provided an economic processing technology can be developed. Furthermore, CFA production is also a matter of serious environmental concern as it is typically placed in landfill and acidic leach liquors containing heavy metals can leach out into the subsoil or contaminate groundwater.

*FJH technology can increase the recovery of rare earth elements (REE) and other critical metals from coal fly ash (CFA).*



## MTM's commercial plan

*Once the pilot scale plant has been tested, the inevitable next step is taking FJH it to commercial scale.*

As MTM continues to develop FJH, it is planning for its eventual commercialisation (Figure 8). Once the pilot scale plant has been tested, the inevitable next step is taking FJH it to commercial scale. It is presently seeking strategic collaborations with industry, government and academia. If NeoMetals (ASX: NMT) is any precedent, we could see a (sub-)licensing deal prior to commercial production. When commercialised, FJH will aim to have a sustainable business model with recurring revenue based on the quantity of material processed.

Figure 8: MTM's commercial steps

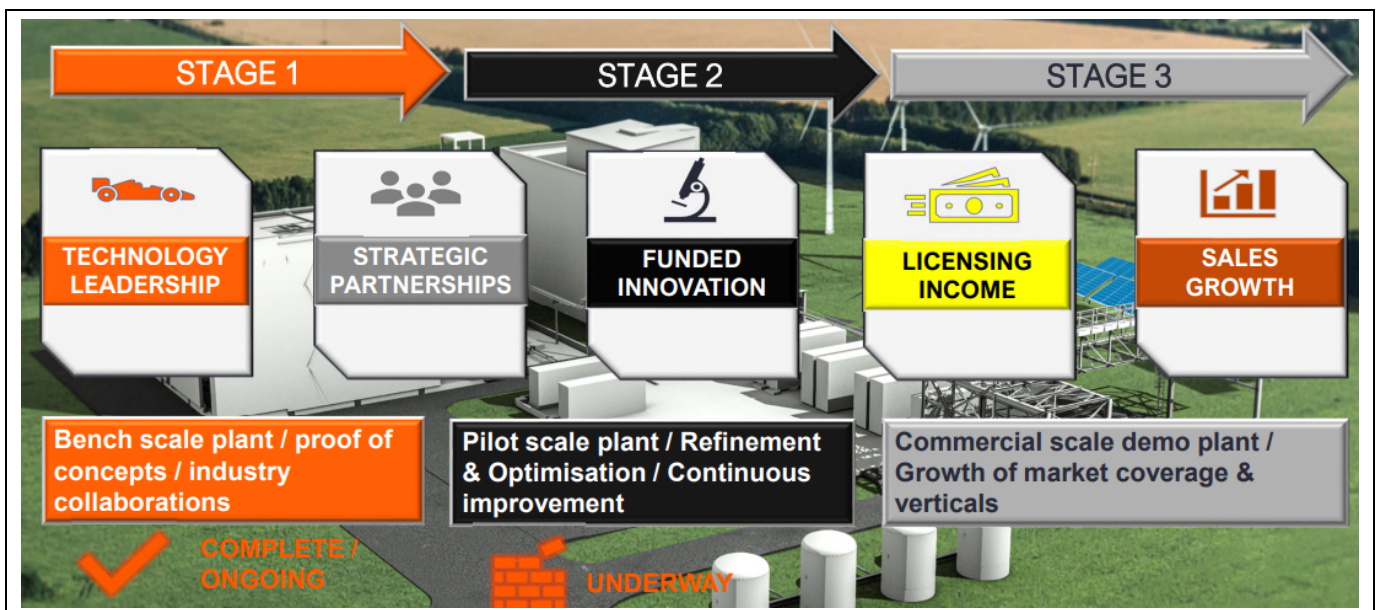

Source: Company

MTM is also seeking non-dilutive funding sources, particularly government grants. Programs such as the Critical Minerals Development Program in Australia and the Critical Minerals & Materials program in the US seek to provide funding towards critical minerals projects so that the supply chain can be diversified before China and nations can still produce the ultimate applications critical metals are used in – particularly defence and decarbonisation applications. ASX companies including Australia Strategic Minerals and Meteoric Resources have received non-binding pledges for their rare earths projects. We envision that FJH, as a company with a technology that can make such a difference to the metals recovery process, would be appealing to the decision makers.





## MTM's leadership team

The company's current board and leadership composition is as follows:

**John Hannaford** is Non-Executive Chairman. is an experienced corporate executive with extensive experience in the ASX resources sector as corporate advisor, executive, chairman, promoter and investor. Mr Hannaford has founded and listed several companies on the ASX. He has established an extensive corporate network and gained a highly distinguished reputation over the last twenty years of corporate life in Australia. A qualified Chartered Accountant and Fellow of the Securities Institute of Australia, he is a co-founder and director of Rockford Partners, a boutique financial services company located in Perth, Western Australia.

**David Izzard** is Non-Executive Director. He has extensive skills in all aspects of financial and commercial management at a senior executive level in both listed and unlisted companies. He has a strong knowledge and experience of mining operations, instrumental in the formulation of a number of junior exploration companies, joint ventures and distribution agreements, and steering companies through successful capital raising, IPOs and trade sale. Mr Izzard is a qualified accountant and has an MBA and a Master of Mineral Economics. He is a co-founder and director of Rockford Partners, a boutique financial services company located in Perth, Western Australia.

**Tony Hadley** is a Non-Executive Director. Mr Hedley is a metallurgist and rare earth element (REE) technical expert with more than 30 years of experience in the mining industry in operations, technical development of complex metallurgical flowsheets, project design and management, engineering and process plant commissioning. He has worked extensively in the REE sector, having previously held the roles of General Manager with both Lynas Corporation (ASX: LYC) at the world-class Mt Weld light REE mine, and subsequently with Northern Minerals Limited (ASX: NTU) at Australia's first heavy REE mine at Browns Range. Mr Hadley is a technical advisor to Meteoric Resources (ASX: MEI) which has an Ionic Clay REE project in Brazil. He holds a BSc in Extractive Metallurgy and Chemistry from Murdoch University.

**Paul Niardone** is Non-Executive Director. He is an experienced director and executive in a range of roles for ASX-listed companies, private entities and not-for-profit organisations. Paul is known as a strategic planner, a problem solver and, above all, a consummate professional, with over 15 years advising and establishing numerous high profile businesses, including the Agency Group Ltd where he has been an executive Director since 2013. Founder and Executive Director of Professional Public Relations, the largest PR and communications firm in Western Australia. Mr Niardone has an extensive network of connections across business and government which have been developed from direct involvement across a range of businesses and sectors. Paul has a degree in Politics and Industrial Relations and an MBA, he started his career in the Department of Cabinet and Parliamentary Services.

**Michael Walshe** is CEO. Mr. Walshe has over 15 years of international experience in engineering, operations, technology commercialisation, and project development roles across the minerals, chemicals, and renewable energy sectors. Mr Walshe joins Voltaic after a 10 year career at Metso:Outotec where positions included Director and Vice President roles for the Asia Pacific Minerals business, in addition to being a member of the executive management team. His experience covers team leadership, metallurgy, process design, sales, and structuring project finance packages for junior miners via export credit funding. Michael has been involved in several



international minerals projects with particular exposure to Asian countries such as Indonesia, the Philippines, PNG and South Korea, and has worked across a wide range of commodities including lithium, rare earths, nickel, copper, zinc and gold. He holds a Bachelor of Chemical and Process Engineering (Hons.) from University College Dublin, Ireland, and a Master of Business Administration (Finance) from the Australian Institute of Business. He is a chartered engineer with both Engineers Australia & the Institution of Chemical Engineers (IChemE), and is a member of the Australasian Institute of Mining & Metallurgy (AusIMM).

**Steve Ragiell** is President – Flash Metals USA (Flash Joule Heating Operations). Mr Ragiell is an experienced CEO and board level executive with proven leadership qualities, extensive company building credentials, an entrepreneurial orientation, and success in applying technology to sustainable business opportunities. He has more than 30 years of worldwide experience in industrial services, environmental services, commercialization of technologies, renewable energy, solid waste recycling and manufacturing businesses. Mr Ragiell has an excellent track record of building teams, implementing business plans, constructing infrastructure, tailoring solutions for customers, developing company culture and company “brand”, reducing unit costs and improving margins in order to create significant shareholder value. He has a strong network across the industrial recycling industry in the US with a strong knowledge base in supply and demand of source material and end products from industrial recycling..

**Simon Adams** is CFO and Company Secretary. He is an experienced CFO with background in a range of industries including mineral exploration, upstream energy sector (oil and gas), aquaculture (pearl production and distribution), hybrid power systems (design and manufacture) and mining (gold exploration and mining). Mr Adams has gained a wide range of experience as a senior member of the executive team in organisations that have had operations globally including USA, Indonesia and Australia. He has a Masters of Accounting from Curtin University, Perth, W. Australia.



## Comparable companies

We have considered companies in the minerals/metals recycling space, first on the ASX, and secondly in North America (Figure 9). As we have valued MTM based on its peers on the ASX, it is important to understand where each of these companies are in order to understand our rationale behind MTM.

Figure 9: Comparable companies

Company	Code	Market Cap (A\$m)	Location	Website
<b>ASX-Listed</b>				
Alpha HPA	ASX.A4N	1220.0	Sydney, Australia	<a href="https://alphahpa.com.au">https://alphahpa.com.au</a>
Silex Systems	ASX.SLX	1260.0	Sydney, Australia	<a href="https://www.silex.com.au">https://www.silex.com.au</a>
Neo Metals	ASX.NMT	72.1	Perth, Western Australia	<a href="https://www.neometals.com.au/en/">https://www.neometals.com.au/en/</a>
IperiorX	ASX.IPX	891	Charlotte, North Carolina	<a href="https://iperionx.com/">https://iperionx.com/</a>
ZeoTech	ASX.ZEO	55.6	Brisbane, Queensland	<a href="https://zeotech.com.au/">https://zeotech.com.au/</a>
Iondrive	ASX.ION	11.9	Adelaide, South Australia	<a href="https://iondrive.com.au/">https://iondrive.com.au/</a>
<b>MTM</b>	<b>ASX.MTM</b>	<b>32.3</b>	<b>Perth, Western Australia</b>	<a href="https://www.mtmcriticalmetals.com.au/">https://www.mtmcriticalmetals.com.au/</a>

Source: Company

## MTM's ASX-listed peers

**Alpha HPA (ASX: A4N)** is commercialising high purity aluminium metals using low carbon HPA refining technology. The company is in Stage 1 of production and is currently building 'Stage 2' which would represent full commercial scale – at 10,4370tpa, making it the largest single-site production of high purity aluminium materials globally. An annual, steady state project EBITDA of A\$255-403m is anticipated.

**Silex Systems (ASX:SLX)** has laser technology that can enrich uranium, silicon and medical isotopes, which have application to nuclear power, quantum computing and cancer therapies respectively. The company is at an early stage, not anticipating commercial operations until later on in the 2020s. However, its market capitalisation has been aided by government grants, investor hype around quantum computing and the energy transition.

**NeoMetals (ASX: NMT)** has a minerals recycling process that uses acids and other fluids to recover the minerals, as opposed to using high temperatures. The company has a cooperation agreement with Mercedes-Benz to supply a ~2,500tpa Integrated Recycling Plant and an exclusive licensing deal with Stelco for 10% gross royalties on sales<sup>19</sup>. NeoMetals is expecting product readiness for a ~21,000toa plant in mid-2025. It has an exclusive licensing deal with Stelco, for a 10% gross revenue royalty once sold.

**IperionX (ASX: IPX)** is the largest company in the peer group, capitalised at over \$680m. It makes titanium alloys from titanium minerals or 100% recycled materials. It has a facility in Virginia that is designed to be the world's largest 100% recycled titanium powder plant. IPX is current completing a PFS (scheduled for completion in October 2024) and before the Pilot Scale Plant.

<sup>19</sup> The deal provides for sales to be royalty free in the event that an option is exercised to acquire 25-50% of equity in Stelco's recycling SPV.



Cost estimation and value engineering are a work in progress. IPX has made first successful titanium production. Full system production capacity and end-to-end system operations are expected in late Q4 2024.

**ZeoTech (ASX.ZEO)** is aspiring to become Australia's first large-scale metakaolin producer. Using kaolin from its Toondoon deposit, it hopes to supply Supplementary Cementitious Material (SCM) for the concrete industry, in order to mitigate carbon emissions. ZeoTech does not yet have off-take agreements or collaboration agreements but has passed extensive testing and completed a test pit.

**Iondrive (ASX.ION)** engages in the exploration and production of battery technology materials, specialising in using Deep Eutectic Solvents (DES) in conjunction with benign organic solvents to recycle metals. The company was formerly known as Southern Gold Limited and changed its name to Iondrive in 2023 upon pivoting from gold exploration. The company is at a PFS stage, expecting completion by the end of CY24. Thereafter it plans to work on a Pilot Scale Plant.

## MTM's Foreign-listed peers

**RecycliCo Battery Materials (TSXV.AMY)** focuses on the research and development of recycling battery cathode waste in lithium-ion batteries in Canada and the United States. Its RecycliCo process produces battery ready materials from modern cathode chemistries, such as Lithium Iron Phosphate, Lithium Manganese Oxide, Nickel Manganese Cobalt, Nickel Cobalt Aluminum, and Lithium Cobalt Oxide. The company is also involved in the exploration of interests in mineral resource projects in British Columbia, and Arizona. RecycliCo Battery Materials Inc. was incorporated in 1987 and is headquartered in Surrey, Canada.

**Electra Battery Materials (TSXV.ELBM)** engages in the acquisition and exploration of cobalt, copper and silver properties in the United States and Canada. It primarily explores for cobalt, copper, and silver deposits. The company's flagship project is the Iron Creek cobalt-copper project in Idaho. It also operates a hydrometallurgical cobalt refinery for producing battery materials for the electric vehicle supply chain. Electra Battery Materials Corporation was incorporated in 2011 and is headquartered in Toronto, Canada.

**RockTech Lithium (TSXV.RCK)** engages in the exploration and development of lithium properties and in developing and optimizing battery grade lithium hydroxide monohydrate. It holds a 100% interest in the Georgia Lake lithium project located in the Thunder Bay Mining District of Ontario. Rock Tech Lithium Inc. was incorporated in 2010 and is headquartered in Toronto, Canada.

**Li-Cycle Holdings (NDQ.LCY)** engages in the lithium-ion battery resource recovery and lithium-ion battery recycling business in North America. The company offers a mix of cathode and anode battery materials, including lithium, nickel, and cobalt, as well as graphite, copper, and aluminium; and copper and aluminium metals. It also provides hub products, such as lithium carbonate, cobalt sulphate, nickel sulphate, and manganese carbonate. Li-Cycle Holdings Corp. is headquartered in Toronto, Canada.

**American Battery Technology (NDQ.ABAT)** explores for resources of battery metals, such as lithium, nickel, cobalt, and manganese; and develops and commercialises technologies for the extraction of battery metals, as well as commercialises integrated process for the recycling of lithium-ion



batteries. The company was formerly known as American Battery Metals Corporation. American Battery Technology Company was incorporated in 2011 and is headquartered in Reno, Nevada.

## Our valuation of MTM

We have used a Peer-Weighted Valuation to value MTM Critical Metals. Although we believe it is too early to use a DCF to the company, it is not unreasonable to derive a valuation from looking at its peers and their stages of development. We think the company deserves to be trading at a premium to ION given MTM is designing a Demonstration Plant, while ION will not have one at least until CY25. Further, MTM has a platform technology with multiple applications from battery and other industrial waste recycling to processing native ore, compared to ION which is focussed on battery recycling only. MTM is currently trading at a premium, but a wafer-thin one.

We think MTM could trade at a market cap of ~A\$63.9m (which is \$0.16 per share) in line with ZEO and NMT once it has passed pilot-scale testing and has secured a licensing deal. We have also constructed a bull case where we ascribe a 30% premium to the market capitalisation, which derives \$83m, or \$0.21 per share. MTM has some way to go to reach a stage worthy of a valuation that IPX has (of over A\$600m), given IPX is formally commercialising its technology before this years' end while A4N is at an early stage of commercialisation.

Figure 10: DCF calculation

Valuation	BASE	BULL
<b>Equity value (A\$ m)</b>	<b>63.9</b>	<b>83.0</b>
Shares outstanding	404.2	404.2
<b>Implied price (A\$ cents)</b>	<b>0.158</b>	<b>0.205</b>
Current price (A\$ cents)	0.080	0.080
Upside (%)	97.5%	156.7%

Source: Pitt Street Research

**We foresee MTM being re-rated** to our valuation range driven by the following factors:

- Completion of a 1 tonne per day pilot/demonstration plant.
- Results related to:
  - i) testing of bauxite residue,
  - ii) recovery of precious metals (gold, platinum etc) from electronic waste.
- Partnerships or collaborations with potential strategic customers and joint-venture partners – both chemical companies and owners of difficult-to-process mineral deposits.
- Securing government grants or other sources of non-dilutive funding in various jurisdictions.
- Further optimisation of the FJH approach.



## Risks

We see the following key risks to our investment thesis:

- **Development risk:** The road to a viable commercial product is very long. Much development and engineering work remains which brings with it a risk of technical failures, or at the very minimum, extended development periods.
- **Funding risk:** MTM will continue to require external funding to support its development plans for the foreseeable future. Raising funds on favourable terms (both debt and equity) along with timeliness may be a challenge for the company. If it secures equity funding, this would dilute shareholder value. Any debt financing would not have this effect, but could present challenges dependant on the terms secured and the progress made by the company.
- **Commercial risk:** Even if and when MTM's technology is commercialised, it will be a challenge in and of itself to find commercial partners for its technology. Lower than anticipated adoption rates may hamper future growth.
- **Licensee risk:** MTM's ability to commercialise the FJH technology is from its licensing of the technology from Rice University. A withdrawal of the license or change in conditions could be catastrophic for the company. Alternatively, existing propositions in the agreement may have the potential to hinder FJH's development and commercialisation.
- **Key personnel risk:** There is the risk the company could lose key personnel and be unable to replace them and/or their contribution to the business.



## Appendix I – Glossary

**Acid Bake/Baking** – A process that transforms metals to sulphate form in the presence of sulfuric acid.

**Bitumen** – a Black viscous mixture of hydrocarbons obtained naturally or as a residue from petroleum distillation.

**Chlorinated** – Impregnated or treated with chlorine

**Coal Fly Ash** – The mineral residue that remains from burning coal.

**Concentrate** – A substance made by removing or reducing the diluting agent.

**Electrons** – A stable subatomic particle with a charge of negative electricity, found in all atoms and acting as the primary carrier of electricity in solids.

**E-waste** – Electronic waste

**Feedstock** – Raw material to supply or fuel a machine or industrial process.

**Flash Joule Heating (FJH)** - a process that the creation of thermal energy because of the collision of electrons in a conductor...done at a 'flash pace'.

**Hydrochloric acid** – A strongly acidic solution of the gas hydrogen chloride in water.

**Hydrometallurgical** – Involving the use of hydrometallurgy. This is the use of aqueous (or watery) solutions for the recovery of metals from ores

**Lithium Carbonate** – A salt-like form of lithium.

**Lithium Chloride** – An anhydrous metal salt.

**Lithium Spodumene** – A hard-rock form of lithium.

**Molar** – This is a unit of concentration of molarity, equal to the number of moles per litre of a solution. Moles are chemical substances that contain several elementary entities (such as atoms, molecules, ions, electrons or photons) but typically immaterial quantities of each individual entity.

**Pilot Scale** – Representative engineering scale model. It is beyond the lab scale, and in a relevant environment, but below commercial scale.

### Pyrolysis

**Pyrometallurgical** – A high-temperature technique that extracts metals from ores/urban waste streams.

**Reagents** – A substance or mixture for use in chemical analysis or other reactions.

**Rare Earth Elements (REEs)** – Any group of chemically similar metallic elements, but generally the 15 elements of the lanthanide species.

**Refractory (metal)** – A class of metals that are extraordinarily resistant to heat and wear, and thus difficult to extract.

**Thermal Energy** – The energy that comes from the heated-up substance.

**Volatilisation** – The transfer of gaseous chemicals into a vapour which escapes into the atmosphere.



## Appendix II – MTM’s exploration Assets

### West Arunta

When MTM acquired 100% of Flash Metals to pick up the FJH Technology, the deal included three exploration licenses prospective for niobium and rare earth elements in the West Arunta region of Western Australia, along with the Mukinbudin Niobium-REE project in the South West Mineral Field of Western Australia. The West Arunta projects are immediately adjacent to tenements held by WA1 Resources (ASX: WA1) and Encounter Resources (ASX: ENR) (Figure 11). The company’s focus has turned to FJH, although it has plans for a first-pass exploration program once it has completed heritage agreements with Local Native Title holders.

Figure 11: West Arunta

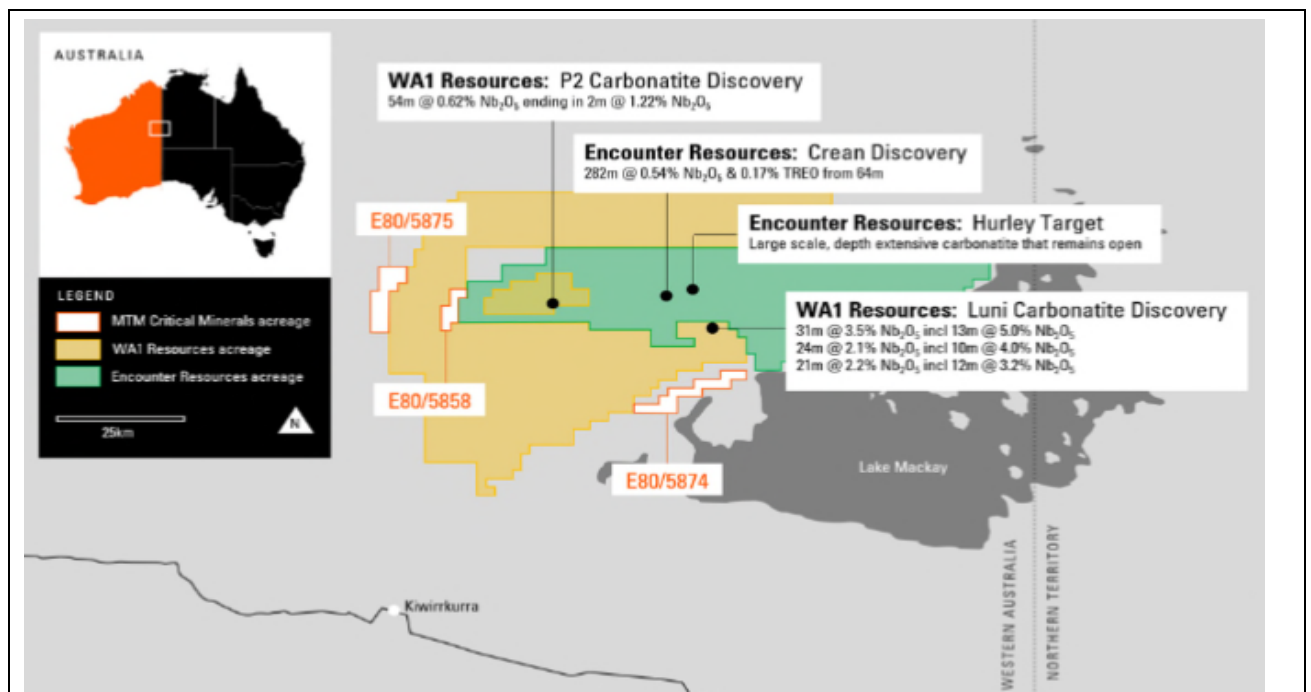

Source: Company

### Pomme

The Pomme project is located in Quebec, Canada (Figure 12). It consists of 43 mineral claims, covering 2,400ha and is the largest Rare-Earth bastnaesite NI43-101 resource estimate in North America, located in Quebec, Canada. The highly accessible project is positioned only 7km from the world class carbonatite-hosted Montviel Deposit which has a resource of 266Mt @ 1.45% TREO. The prospect has proven carbonatite mineralisation with 2 historic drill holes confirming mineralisation over 478m from 25m and grades reaching as high as 1.58% TREO and 0.19% Nb.

The property is located in the Montviel Township, which is 93 km away from the town of Lebel-sur-Quevillon, where services and manpower are available. The project has access to Hydro-Power via local infrastructure and with a





relatively flat topography, is consequently easily accessible via a logging road. Covered by a mix of swamp and forest, the latter consisting mainly of black spruce.

Figure 12: Pomme

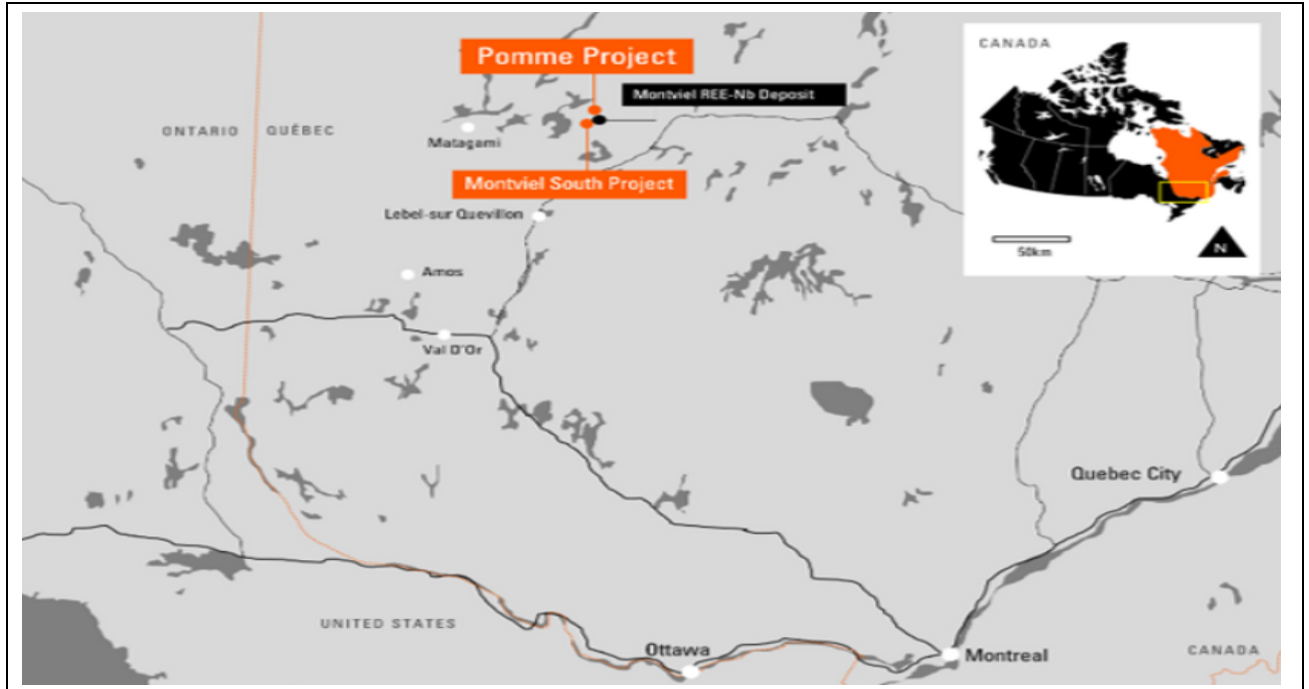

Source: Company

## East Laverton

The East Laverton Project comprises twelve exploration licences, covering an area of approximately 3,000km<sup>2</sup> in the highly prospective East Laverton region of Western Australia, 50-100 km east of Laverton and 350km northeast from Kalgoorlie-Boulder (Figure 13). The project is located within the Eastern Goldfields Superterrane on the eastern part of the Archean Yilgarn Craton.

The poorly exposed granite greenstone terranes of the eastern Yilgarn Craton include some of the world's most mineralised belts and host world class gold deposits. Due to extensive transported cover, the project area has had limited historical exploration, despite being surrounded by existing and emerging world class gold camps.

To the west, the Laverton Greenstone Belt is home to Sunrise Dam (10 Moz Au), Wallaby (8 Moz Au) and Granny Smith (2.5 Moz Au) and a suite of other nearby gold deposits. Gold production from the belt is estimated to be in excess of 28 Moz Au.

Lying to the east of the area is the Yamarna Greenstone Belt, hosting the 6 Moz Au granitoid-hosted Gruyere deposit, whilst the 7.5 Moz Au granite gneiss-hosted Tropicana deposit is located in the Albany-Fraser Province to the southeast.



Figure 13: East Laverton

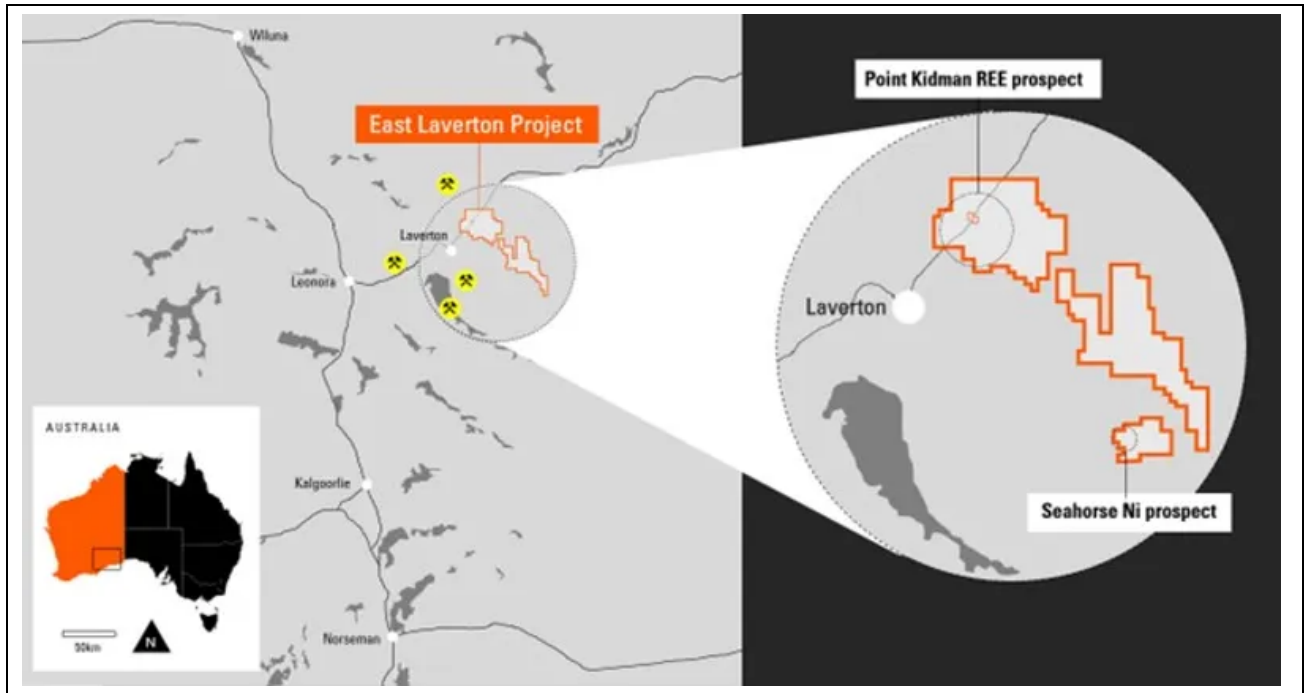

Source: Company



## Appendix III – MJM’s Capital Structure

Capital	Number	% of share capital
Shares on issue pre-raising	281.1	47%
Tranche 1 of Capital Raising	64.7	11%
Tranche 2 of Capital Raising	58.4	10%
<b>Total Ordinary Shares</b>	<b>404.2</b>	<b>68%</b>
Existing Listed Options (expire Nov-24)	173.9	29%
Options to be Issued to Lead Manager	20.0	3%
<b>Fully diluted shares</b>	<b>598.1</b>	<b>100%</b>

Source: Company

Note: Tranche 2 shares and Options to be Issued to Lead Manager to be issued subject to shareholder approval at AGM in November 2024.

## Appendix IV – Analysts’ Qualifications

Stuart Roberts, lead analyst on this report, has been an equities analyst since 2002.

- Stuart obtained a Master of Applied Finance and Investment from the Securities Institute of Australia in 2002. Previously, from the Securities Institute of Australia, he obtained a Certificate of Financial Markets (1994) and a Graduate Diploma in Finance and Investment (1999).
- Stuart joined Southern Cross Equities as an equities analyst in April 2001. From February 2002 to July 2013, his research speciality at Southern Cross Equities and its acquirer, Bell Potter Securities, was Healthcare and Biotechnology. During this time, he covered a variety of established healthcare companies, such as CSL, Cochlear and Resmed, as well as numerous emerging companies. Stuart was a Healthcare and Biotechnology analyst at Baillieu Holst from October 2013 to January 2015.
- After 15 months over 2015–2016 doing Investor Relations for two ASX-listed cancer drug developers, Stuart founded NDF Research in May 2016 to provide issuer-sponsored equity research on ASX-listed Life Sciences companies.
- In July 2016, with Marc Kennis, Stuart co-founded Pitt Street Research Pty Ltd, which provides issuer-sponsored research on ASX-listed companies across the entire market, including Life Sciences companies.
- Since 2018, Stuart has led Pitt Street Research’s Resources Sector franchise, spearheading research on both mining and energy companies.

Nick Sundich is an equities research analyst at Pitt Street Research.

- Nick obtained a Bachelor of Commerce/Bachelor of Arts from the University of Sydney in 2018. He has also completed the CFA Investment Foundations program.
- He joined Pitt Street Research in January 2022. Previously he worked for over three years as a financial journalist at Stockhead.
- While at university, he worked for a handful of corporate advisory firms

## General advice warning, Disclaimer & Disclosures

### Terms & Conditions

The information contained herein ("Content") has been prepared and issued by Pitt Street Research Pty Ltd ACN 626365615 ("Pitt Street Research"), an Authorised Representative (no: 1265112) of BR Securities Australia Pty Ltd. ABN 92 168 734 530, AFSL 456663. All intellectual property relating to the Content vests with Pitt Street Research unless otherwise noted.

### Disclaimer

Pitt Street Research provides this financial advice as an honest and reasonable opinion held at a point in time about an investment's risk profile and merit and the information is provided by the Pitt Street Research in good faith. The views of the adviser(s) do not necessarily reflect the views of the AFS Licensee. Pitt Street Research has no obligation to update the opinion unless Pitt Street Research is currently contracted to provide such an updated opinion. Pitt Street Research does not warrant the accuracy of any information it sources from others. All statements as to future matters are not guaranteed to be accurate and any statements as to past performance do not represent future performance.

Assessment of risk can be subjective. Portfolios of equity investments need to be well diversified and the risk appropriate for the investor. Equity investments in a listed or unlisted company yet to achieve a profit or with an equity value less than \$50 million should collectively be a small component of an individual investor's equity portfolio, with smaller individual investment sizes than otherwise. Investors are responsible for their own investment decisions, unless a contract stipulates otherwise.

Pitt Street Research does not stand behind the capital value or performance of any investment. Subject to any terms implied by law and which cannot be excluded, Pitt Street Research shall not be liable for any errors, omissions, defects or misrepresentations in the information (including by reasons of negligence, negligent misstatement or otherwise) or for any loss or damage (whether direct or indirect) suffered by persons who use or rely on the information. If any law prohibits the exclusion of such liability, Pitt Street Research limits its liability to the re-supply of the Information, provided that such limitation is permitted by law and is fair and reasonable.

### General advice warning

The Content is General Financial Advice but has been prepared for general information purposes only and is not (and cannot be construed or relied upon as) Personal Financial Advice nor as an offer to buy/sell/subscribe to any of the financial products mentioned herein. No investment objectives, financial circumstances or needs of any individual have been taken into consideration in the preparation of the Content.

Financial products are complex, entail risk of loss, may rise and fall, and are impacted by a range of market and economic factors, and you should always obtain professional advice to ensure trading or investing in such products is suitable for your circumstances, and ensure you obtain, read and understand any applicable offer document.

### Disclosures

Pitt Street Research has been commissioned to prepare the Content. From time to time, Pitt Street Research representatives or associates may hold interests, transact or hold directorships in, or perform paid services for, companies mentioned herein. Pitt Street Research and its associates, officers, directors and employees, may, from time to time hold securities in the companies referred to herein and may trade in those securities as principal, and in a manner which may be contrary to recommendations mentioned in this document.

Pitt Street Research receives fees from the company referred to in this document, for research services and other financial services or advice we may provide to that company. The analyst has received assistance from the company in preparing this document. The company has provided the analyst with communication with senior management and information on the company and industry. As part of due diligence, the analyst has independently and critically reviewed the assistance and information provided by the company to form the opinions expressed in the report. Diligent care has been taken by the analyst to maintain an honest and fair objectivity in writing this report and making the recommendation. Where Pitt Street Research has been commissioned to prepare Content and receives fees for its preparation, please note that NO part of the fee, compensation or employee remuneration paid will either directly or indirectly impact the Content provided.